

Ev Portable Charger User Manual



English



CAUTION:

- Before operation, please read the operation guide in detail to understand the correct use of the equipment. After reading, please keep it properly for future reference.
- Use the power source with external upstream Circuit Breaker.
- Make sure the charger is used in a safe, secure place and well out of the reach of young children or pets.
- Please use the charger in a dry, well ventilated and secure place. Keep well out of reach of young children or pets. Avoid water pouring directly onto the power plug .
- Do not open the enclosure while charging or with the power on.
- Do not maliciously damage the product.



Repair or maintenance work not described in this manual may only be performed by an authorized dealer.

Contents

1. Introduction.....	02
2. Technical parameters.....	03
3. Explanation of the operating display.....	03
4. Use of the charger.....	04
Start charging.....	04
Stop charging.....	04
5. Function.....	05
Switch Current.....	05
Timerfunction.....	05
6. Light Status.....	06
7. Product after-sales.....	06

Introduction

Introduction to the Portable EVCharger(Mode 2)

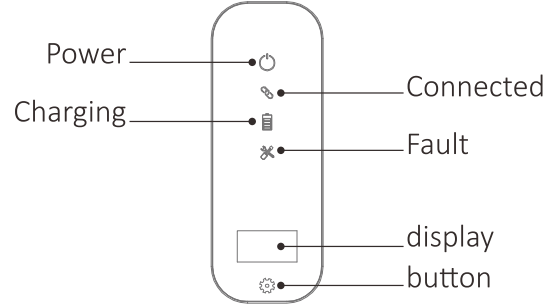
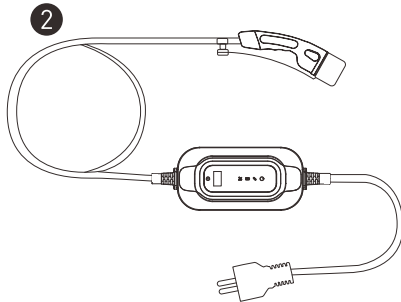
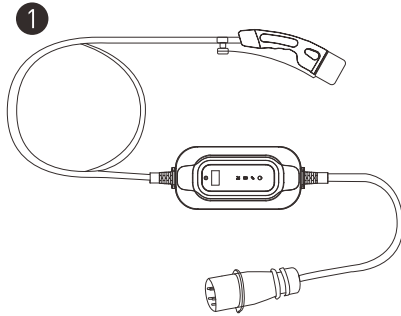

Specifications

Model	Power Supply Type	Cable Total Length	Voltage	Current	Connector Type
EL220-03AC1-EU-B-T-P2C2	TN/TT/IT 1ph	5/8/10/15m	200-250VAC	8/10/13/16A	T2
EL220-03AC1-EU-B-T-P2C1	TN/TT/IT 1ph	5/8/10/15m	200-250VAC	8/10/13/16A	T1
EL220-03AC1-EU-B-T-P4C2	TN/TT/IT 1ph	5/8/10/15m	200-250VAC	8/10/13/16A	T2
EL220-03AC1-EU-B-T-P4C1	TN/TT/IT 1ph	5/8/10/15m	200-250VAC	8/10/13/16A	T1
EL220-03AC1-EU-B-T-P5C2	TN/TT/IT 1ph	5/8/10/15m	200-250VAC	8/10/13/16A	T2
EL220-07AC1-EU-B-T-P5C2	TN/TT/IT 1ph	5/8/10/15m	200-250VAC	8/10/13/16/ 20/25/32A	T2

Technical parameters



S/N	Item	Parameters
1	Rated voltage	230VAC±15% 1ph TN/TT/IT
2	Grid frequency	50/60 Hz
3	IP protection class	IP65
4	Operating temperature	-30 C ~+50 C
5	Storage temperature	-40 C ~+85 C
6	Humidity	Up to 75%, maximum value at 40 C
7	Altitude	up to 4000 m
8	Protection	Over-voltage protection Under-voltage protection Over-current protection Short-circuit protection Ungrounded protection Over-temperature protection A+6mA Leakage protection1ph
9	Operating instruction	LED & Display
10	Dimensions	200 (L) ×100 (W) ×55 (H) mm
11	Weight	1.75 kg /2.78 kg
12	Standards	EN 62752:2016 EN IEC 61851-1:2019 IEC 62196-1:2014 IEC 62196-2:2016

Explanation of the operating display

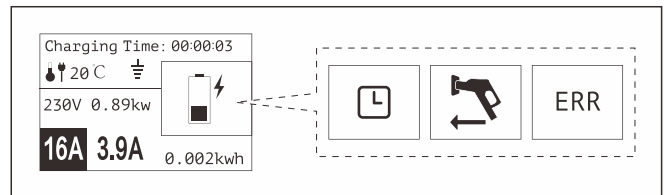

00:00:03	Charging time	3.9A	Constant current
🔥 20 C	Temperature		countdown
⚡	Grounding		Standby
230V	Voltage		Charging
0.89kw	Power	ERR	Error
16A	Rated current	0.002kwh	Electricity consumption

Use of the charger

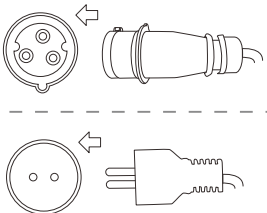
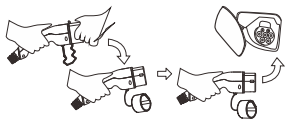
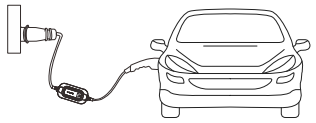

Start charging

Step	Illustration	Operation
1		Insert the plug into the correct power supply socket.
2		Remove the protective cap and fully insert the charging connector into the EV charging port.
3		Start charging

DANGER

- Do not use the product if it appears to be damaged or the cable is broken.
- Do not disassemble or assemble the connector and change the internal parts.
- Do not clean the products using chemicals or cleaning the EV car while charging.

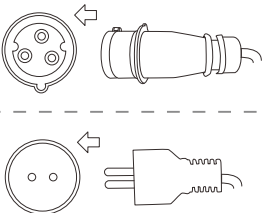
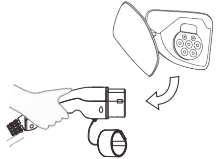
Stop charging

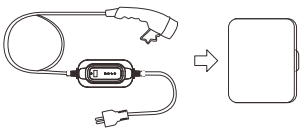
Step	Illustration	Operation
1		Insert the plug into the correct power supply socket.
2		Disconnect the charging connector from the EV car.
3		Close the protective shell of EV charging port, then cover the protective cap of the charging connector.
4		Put the portable charger into the package.

Function

Switch Current

Step	Illustration	Operation
1		Insert the plug into the correct power supply socket.
2		Press the Setting button for 2 seconds, no more than 4 seconds. Then release it, to enter setting the switch current mode.
3		Continue to press the button briefly. The current will be changed (switch between 8-10-13-16A or 8-10-13-16-20-25-32A). Setting the current as User's request.
4		Press the button for 2 S again. Setting successfully.

CAUTION

- In order to switch charging current, Please make sure the power plug is firmly inserted into the socket and plug for the EV vehicle is disconnected.
- Please complete setting within 4 seconds at each step, otherwise the feature setting will fail.

Timer function

























Step	Illustration	Operation
1		Insert the plug into the correct power supply socket.
2		Press the Setting button for more than 4 seconds. Enter setting the delay time mode.
3		Continue to press the button briefly. The time will be changed (Switch between 1/2/4/6/8/10H). Setting the delay time as User's request.
4		Press the button for 2 S again. Setting successfully.

Notice:













- In case you want to cancel the timer setting, you can use one of the two options below:
1. Directly to disconnect the plug from the outlet socket.
 2. Press the Time button for more than 4 S.

Light Status

























Operation

1	Power Off				
2	Check				
3	Standby				
4	Connected				
5	Charging				
6	Charge Complete				

Display Light Status

Status \ Light	Off	Blink	On
Power			
Connect			
Charging			
Fault			

Troubleshooting

7	CP Error				
8	Over/Under Voltage				
9	Over current protection				
10	Electric leakage protection				
11	Noground connection				
12	Temperature warning				
13	Persistent high temperature	